

香港工商業獎

**2019
HONG KONG
AWARDS FOR
INDUSTRIES**

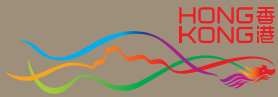

**創意
Innovation
and Creativity**

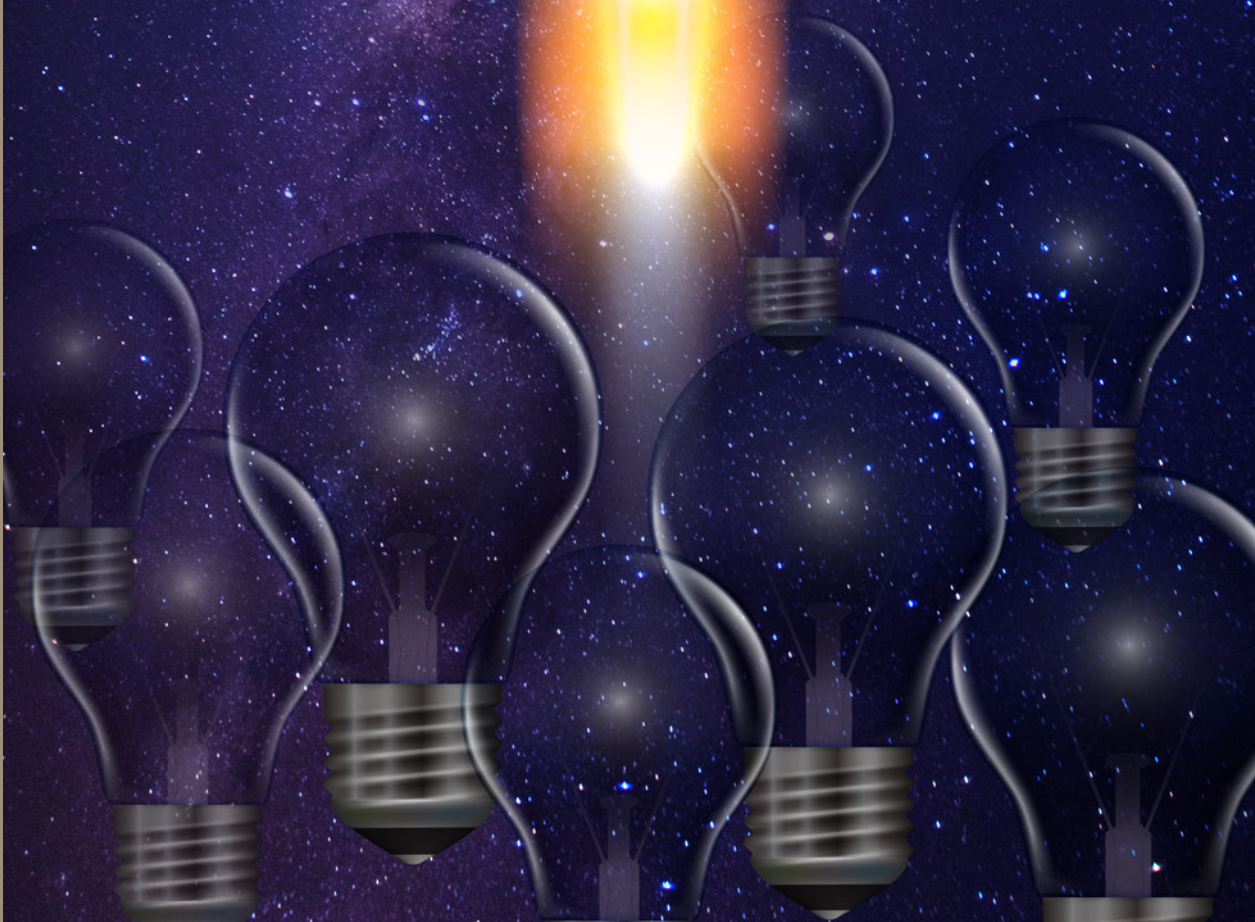

HKGCC

Hong Kong General Chamber of Commerce
香港總商會 1861

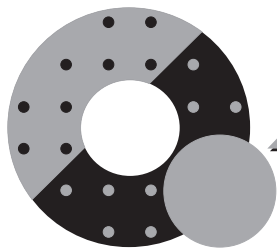

2019 香港工商業獎：創意

Hong Kong Awards for Industries: Innovation and Creativity



香港工商業獎

2019
HONG KONG
AWARDS FOR
INDUSTRIES

創意大獎
INNOVATION
AND CREATIVITY
GRAND AWARD



煤氣
Towngas

香港中華煤氣有限公司
The Hong Kong and China Gas Company Limited



2019
香港工商業獎
HONG KONG AWARDS
FOR INDUSTRIES

創意獎
INNOVATION AND
CREATIVITY AWARD



匯能印藝有限公司
Artech Graphics Limited



交通銀行（香港）有限公司
Bank of Communications (Hong Kong) Limited

FANO 有光科技
Labs

有光集團有限公司
Fano Labs Limited



鴻興印刷集團有限公司
Hung Hing Printing Group Limited

ARUP

奧雅納工程顧問
Ove Arup & Partners Hong Kong Ltd



2019
香港工商業獎
HONG KONG AWARDS
FOR INDUSTRIES

創意優異證書
INNOVATION
AND CREATIVITY
CERTIFICATE OF MERIT

BNET

必靈科技有限公司
BNET-TECH Company Limited

PCCW Solutions®

電訊盈科企業方案有限公司
PCCW Solutions Limited

PHASE SCIENTIFIC
相達生物科技

相達生物科技國際有限公司
PHASE Scientific International Limited



夏雅朗博士

香港總商會主席

「2019 香港工商業獎」獲香港商界的鼎力支持和參與，得以成功續辦，實在可喜可賀。本人謹此衷心祝賀各獎項得主，包括香港總商會主辦「創意」組別的 9 間優勝公司。

企業要在現今市場脫穎而出，必須創優增值，透過引入創意創新，率先開發嶄新的意念、產品和服務，務求令顧客感到物超所值。科技發展一日千里，加上全球化的趨勢，正不斷顛覆和重塑商業生態，令世界變得愈來愈小，各地的距離得以拉近。有鑒於此，本港企業必須與時並進，勇於求變，否則或被淘汰。

香港一而再地證明，本地企業有決心、有能力研發嶄新方案，以開拓新興市場，把握新商機。這從今年參賽公司的實力可見一斑；他們成功把獨特、有趣及富啟發性的意念付諸實踐，成就了多項具市場價值的商業方案。我欣賞各得獎企業的遠見、勇氣和努力，把創新想法轉化為商機。

總商會很榮幸再度獲邀主辦今屆「創意」組別獎項。我謹代表總商會，向香港工商業獎最終評審委員會和總商會評審委員會的全體成員致以由衷謝意，感激他們不吝付出時間參與評審過程，貢獻所長。

總商會作為商界之聲，我們定當繼續積極提升香港的競爭力。新年將至，我謹祝諸位在新的一年里更上一層樓！

Dr Aron H Harilela, BBS, JP

Chairman, Hong Kong General Chamber of Commerce

I would like to begin by extending my heartiest congratulations to all the winners of the 2019 Hong Kong Awards for Industries, which have continued to enjoy enthusiastic support and participation from the Hong Kong business community. I would like to especially recognize the achievements of the 9 winners in the "Innovation and Creativity" category of the Awards, organized by the Hong Kong General Chamber of Commerce.

For companies to succeed today, they must be more innovative, more creative and able to add more value than their competitors. They will have to develop new ideas, products and services that their customers value highly, and they will have to do it faster than anyone else around them. The world is becoming increasingly smaller and flatter as the forces of technology and globalization continuously disrupt and reshape the business landscape as we know it. Like it or not, Hong Kong businesses must keep up with and adapt to such changes or run the risk of becoming obsolete.

Hong Kong has shown time and time again that it has the will and capability to develop innovative solutions to address emerging markets and capture new opportunities. This is evident from this year's Award entrants, who have displayed a range of ideas and concepts that are simultaneously unique, interesting and inspiring. More importantly, these are market-proven and commercially viable. I applaud the winners for their vision, courage and efforts to bring their ideas to life.

The Chamber is again honoured to be the lead organizer for this year's award category on "Innovation and Creativity." On behalf of the Chamber, I would like to extend my sincere thanks and appreciation to all the members of the Final Judging Panel and HKGCC Judging Panel for devoting their time and expertise to the evaluation process.

As the Voice of Business in Hong Kong, the Chamber will continue to play an active role in enhancing Hong Kong's competitiveness. As we welcome the New Year, I would like to extend my best wishes to everyone for a successful and productive 2020.



香港工商業獎

2019
HONG KONG
AWARDS FOR
INDUSTRIES

創意大獎
INNOVATION
AND CREATIVITY
GRAND AWARD

香港中華煤氣有限公司 The Hong Kong and China Gas Company Limited



香港中華煤氣有限公司（煤氣公司）於1862年成立，是香港歷史最悠久的公用事業機構。多年來煤氣公司與時並進，由初期供應煤氣燃點街燈，發展到今天成為香港及中國內地的主要能源供應商之一。

現時的對衝式熱水爐需要客戶定期更換電池。煤氣公司研發的熱水爐水力發電模組，能夠把水流轉為電能，再將之儲存在特別設計的電容器內，以取代電池。這不但避免廢棄電池帶來的環境污染，客戶亦無需再為更換電池而煩惱。這個附加裝置適用於新安裝的熱水爐，或加裝於現有的熱水爐。

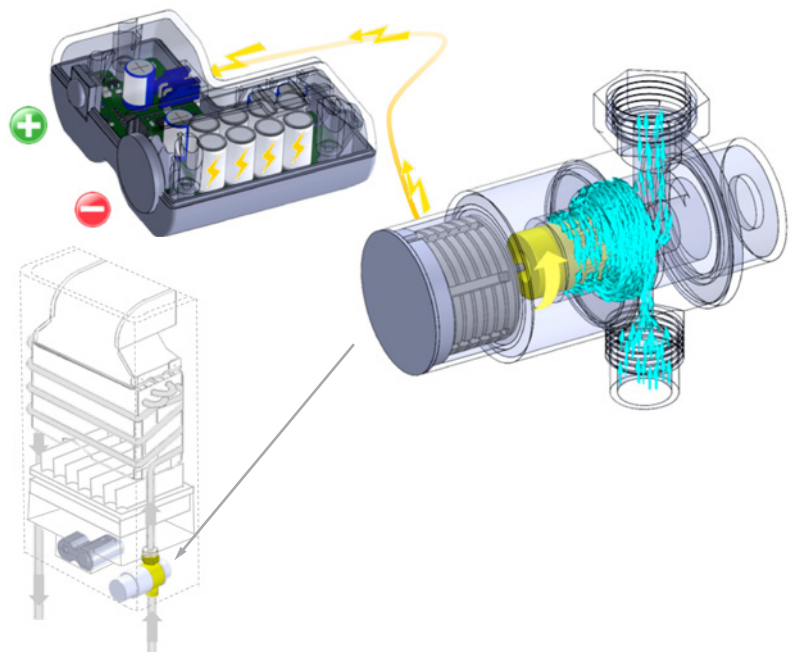



Founded in 1862, The Hong Kong and China Gas Company Limited, known as Towngas, was the first public utility in Hong Kong. Since then, it has evolved from supplying fuel for street lamps to one of the main energy suppliers in Hong Kong and Mainland China.

The current models of balanced-flue water heaters require customers to regularly replace the batteries. An alternative to batteries, developed by Towngas, is the water heater hydropower generator module. This converts water flow to electric power, which is stored in a specially designed capacitor set. This not only eliminates environmental pollution created by battery disposal, but also the inconvenience for customers of having to replace the batteries. The add-on device is suitable for new installations and can also be retrofitted to existing water heaters.

www.towngas.com

香港總商會評審委員會之評語

熱水爐水力發電模組利用水流取代即棄電池來產生電力，以供點燃煤氣和啟動熱水爐內各種安全監察功能。這項產品令煤氣熱水爐無須依靠即棄電池供電，大幅減少了即棄電池的使用，可謂更環保，又更符合成本效益。水力發電模組的壽命為十年。這個創新理念每年可減少對衝式氣體熱水爐消耗最少80,000個普通電池。

該公司建立的內部文化，有助鼓勵創新思維，令創新技術（如熱水爐水力發電模組）的潛力得以充分發揮。該產品革新了點燃的供電方式；隨著這類環保產品受到愈來愈多國家歡迎，該產品在海外市場潛力龐大。

Comments by the HKGCC Judging Panel

A hydroelectric-powered trigger uses the movement of flowing water instead of disposable batteries to generate energy for ignition and the safety monitoring functions in water heaters. The product minimises the use of disposable batteries and is therefore more cost effective and environmentally friendly. The innovative idea of a water-powered trigger with a life span of 10 years would eliminate the need for at least 80,000 conventional batteries every year in balanced-flue gas water heaters.

The company has an internal culture that is conducive to encouraging innovative ideas and developing the full potential of innovations such as the trigger. The product revolutionises the power supply of the ignition method, and has great potential in overseas markets, as more countries welcome environmentally friendly products such as this one.



匯能印藝有限公司 Artech Graphics Limited

ARTECH
Solution of Graphics Communication



匯能印藝有限公司成立已25年，從事專業的印刷色彩管理、包裝設計及樣辦製作服務，協助客戶提昇品牌價值及形象。

五年前，匯能印藝結合多年對紙張材料應用、結構的專業知識，開創了特有的環保展示方案，以環保物料製造創新、具成本效益的展示系統，配合政府大力倡議在籌辦展覽和活動時減廢及回收的方向，實踐減少、再用及循環再造。

Artech Graphics Limited, established in 1994, provides pre-press solutions including colour management, packaging design and packaging mock-up production. It empowers brand specialists and marketers by helping them create effective print and brand management to strengthen their retail and brand identity.

Five years ago, Artech Graphics developed its Eco Décor Solution, which applies the company's expertise in application and structure paper material to offer an environmental-friendly, innovative, creative and cost-effective approach. Artech Graphics also works with its clients to organize events and exhibitions that echo the Government-advocated green practices in waste reduction and recycling for event organizers, fulfilling the aim of Reduce, Reuse and Recycle.

www.artechgraphics.com.hk

香港總商會評審委員會之評語

Eco Décor Solution 提供一系列的設計和產品，從基本產品展示到全由環保紙材和紙板組合而成的快閃商店，包羅萬有。該公司憑藉豐富的印刷經驗和技術，創作出嶄新的展示裝飾和展覽布置，發掘新的商機。這個本地創新方案利用創意設計和環保物料，為市場開創了嶄新的商業服務。

Comments by the HKGCC Judging Panel

Eco Décor Solution offers a selection of designs and products that range from basic product displays to pop-ups made completely of eco-friendly paper and cardboard. The applicant explores new business opportunities by using its ample printing experience and capabilities to create new displays and exhibition panels. This is a local innovation that facilitates new business services by making use of creative designs and environmentally friendly materials.

交通銀行（香港）有限公司 Bank of Communications (Hong Kong) Limited



交通銀行（香港）有限公司致力為客戶提供多元化的財富管理產品及服務。銀行利用嶄新的科技元素提升客戶體驗，從而鞏固客戶關係，並擴闊客源。

「交銀智易通」從客戶角度出發，以最新科技為客戶打造「開戶即發卡」的全新服務體驗，藉此推動該行在金融科技新時代的發展。

Bank of Communications (Hong Kong) Limited offers diversified wealth management products and services. The bank serves its customers by leveraging new technological elements to enhance customer experience, to strengthen customer relationships, and to expand its customer base.

The idea to develop the Smart Kiosk was inspired by the bank's customers. The Smart Kiosk applies the latest technologies to optimize the whole process of "account opening with instant card issuance" and has created a brand new service. The company intends that the success of this project and future initiatives will accelerate the bank's development in the new fintech era.

www.hk.bankcomm.com



香港總商會評審委員會之評語

「交銀智易通」是銀行首部提供無人自助開戶服務的智能櫃員機。客戶開立銀行賬戶一般需時 40 至 60 分鐘，而通過「交銀智易通」，則只需 15 至 20 分鐘，期間更無需職員協助。智能櫃員機結合人工智能、大數據分析和面部識別等最新的 eKYC（電子化認識你的客戶）技術，讓銀行能夠加快註冊和驗證程序。「交銀智易通」還包含互動功能，以提升用戶體驗。

智能櫃員機展示出該行致力開發創新的方式，紓緩前線客戶服務員工的壓力。

Comments by the HKGCC Judging Panel

Smart Kiosk is the bank's first unmanned kiosk that enables clients to open bank accounts within 15-20 minutes with no human interaction, a process that usually takes 40-60 minutes to complete. Through the Smart Kiosk, the bank is able to accelerate the registration and verification process by using the latest eKYC (Know Your Customer) technologies comprising AI, big data analysis and facial recognition. The Kiosk also includes interactive functions to enhance user experience.

The Smart Kiosk demonstrates how the bank is developing innovative ways to alleviate pressure on frontline staff when providing services to customers.



有光集團有限公司 Fano Labs Limited

FANO Labs 有光科技

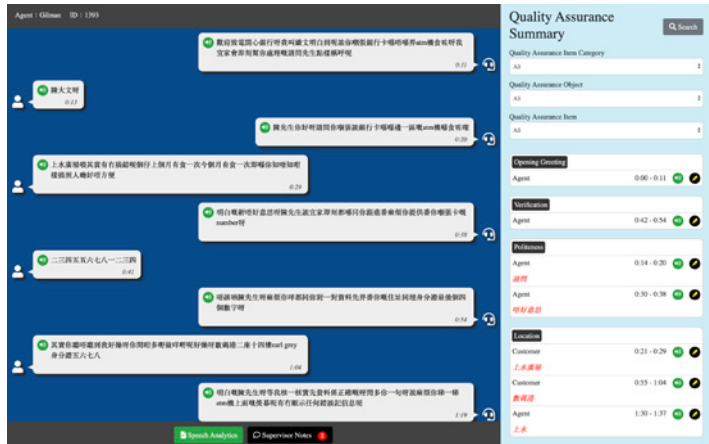

有光科技是一家創立於香港的人工智能公司，致力研發不同語言和方言的語音識別和自然語言處理技術，為各行各業提供客戶服務、合規審查和其他業務解決方案。

有光科技利用先進的人工智能技術，為不同行業提供智能客戶服務及言語分析系統。該系統能夠準確辨識潛在的合規風險，以及偵測和分析顧客的情緒，協助客戶提升管理能力和服務質素。系統亦為管理人員提供寶貴的商業情報，有助企業發掘潛在商機，從而增加收入。

Fano Labs is a Hong Kong AI company specialising in Speech Recognition and Natural Language Processing technologies, focusing on a variety of languages and dialects. Fano Labs' solutions help enterprises from different sectors with customer service, compliance and other areas of business.

With its advanced AI technologies, Fano Labs provides a smart Customer Service and Speech Analytics System. Its customers can enhance their management capabilities and service quality by accurately identifying potential compliance risks while detecting and analysing the sentiment of the customers. The system also allows enterprises to uncover potential sales opportunities by providing managers with valuable business intelligence, which can help increase revenue.

www.fano.ai

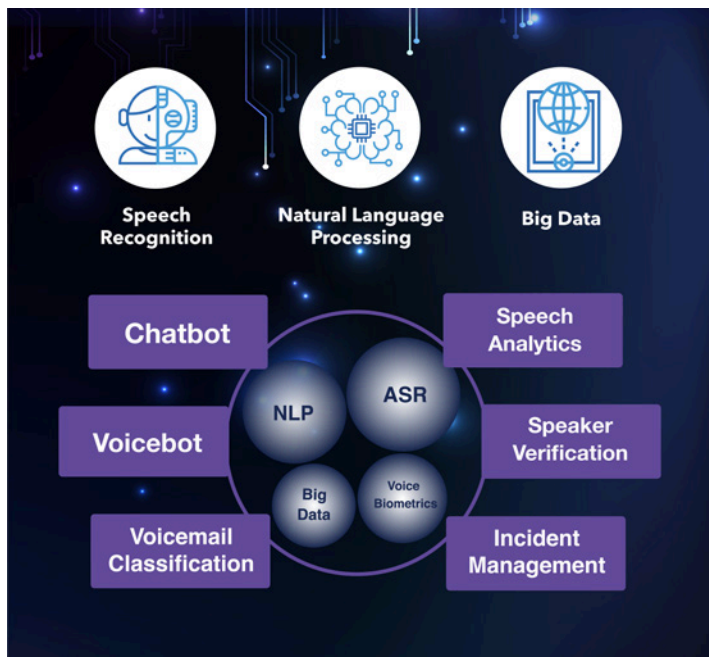

香港總商會評審委員會之評語

有光科技有限公司專門從事語言科技，並已成功把其科研成果轉化為商品。人工智能客戶服務系統利用人工智能技術，提供精密而實用的語音識別服務，是本土創新的典範。該公司的增長潛力龐大，而這項技術亦可望推動香港的智慧城市發展。

Comments by the HKGCC Judging Panel

Fano Labs Limited, which specialises in speech and language technologies, has successfully demonstrated its ability to use scientific research to develop a commercially viable product. Artificial Intelligence Customer Service System is a great example of local innovation, using AI technology to develop sophisticated and practical transcription services. The company has a strong potential for growth, and hopes that the technique can be used in developing Hong Kong into a Smart City.

鴻興印刷集團有限公司 Hung Hing Printing Group Limited



智能生產計劃平台是一個專為實現「工業4.0」而設的商業方案，旨在透過革新和簡化生產規劃、安排、發送、執行和監測表現的方式，優化機器使用率、提升整體生產力和增加透明度。

該平台尤其適用於複雜的接單生產模式，以及涉及多個生產工序的產品。

智能生產計劃平台利用高等演算法，根據產品規格、交貨日期和優先次序等條件，自動編配最佳的生產排期。訂單會交由最合適的機組進行生產，以提升效率。透過物聯網裝置收集機器的實時生產數據，管理層可透過手機應用程式監控生產進度。

這個多模組方案結合企業資源規劃（ERP）系統，協助實現智能工廠，為製造商創造真正的商業價值。

Smart Planning is an Industry 4.0 solution for manufacturing that optimizes machine utilization, enhances overall productivity and increases transparency by transforming and simplifying the way manufacturers plan, schedule, dispatch, execute and monitor performance.

It is especially well-suited to complex make-to-order manufacturing environments and products that require many manufacturing tasks.

Smart Planning uses advanced algorithms to automatically compute the most optimal production schedule based on order specifications, delivery date and priority. Work orders are assigned and dispatched by the most suitable set of machines for efficient production. IoT devices collect real-time production data from machines to monitor progress through mobile applications.

This multi-module solution combines with traditional ERP systems to enable digital practices in smart factories and to deliver real business value to manufacturers.

www.hunghingprinting.com

香港總商會評審委員會之評語

智能生產計劃平台憑藉內部開發的演算法，徹底顛覆了印刷訂單排期的傳統方法。鴻興印刷集團通過旗下的資訊科技團隊和內部會議，營造了一種創新的企業文化。該公司利用物聯網和成熟的大數據技術，為製造業開創了嶄新的解決方案，更有助促進「工業4.0」在香港的發展。該公司估計，印刷訂單排期系統通過提升生產力，為他們帶來了7,100萬港元的收入之餘，同時把人手排期所需的時間減省了95%。

Comments by the HKGCC Judging Panel

Smart Planning Solution revolutionises the traditional method of prioritising orders for printing through an internally developed algorithm. Hung Hing Printing Group encourages an innovative corporate culture through its in-house IT team and internal meetings. The company has introduced a new solution for manufacturing to take advantage of the Internet of Things and mature big data techniques, which should help strengthen the adoption of Industry 4.0 in Hong Kong. The applicant estimates the scheduling system has generated HK\$71 million in revenues through productivity gains and reduced the time needed to manually schedule printing tasks by 95%.



奧雅納工程顧問 Ove Arup & Partners Hong Kong Ltd

ARUP

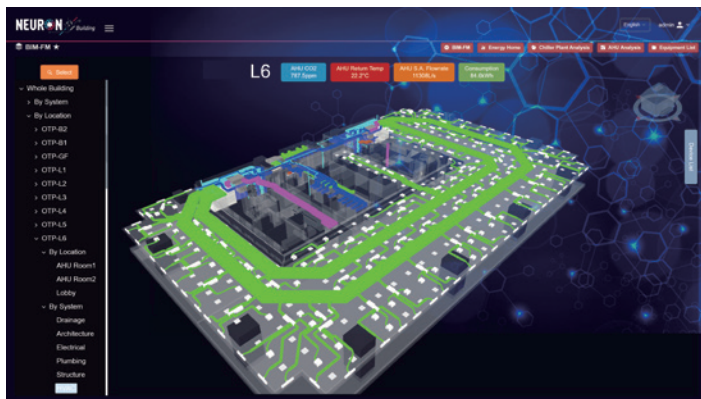
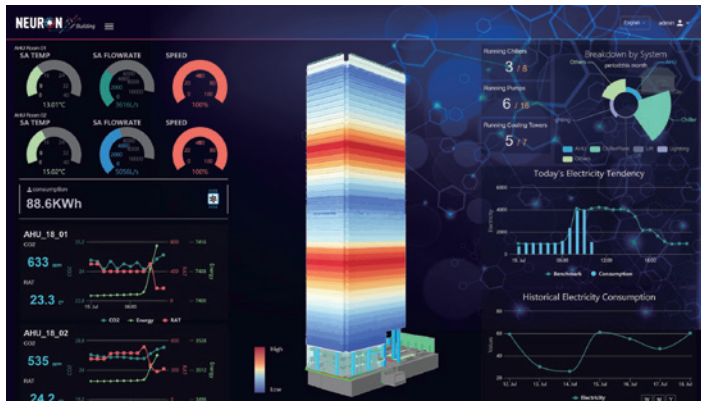

奧雅納是全球眾多知名項目的核心創意力量，在33個國家和地區設立了88家分支機構，擁有逾14,000名設計、工程、規劃和諮詢專業人員，在世界各地營建創新項目。

奧雅納開發的Neuron智慧建築數字化平台集中監控樓宇自動化和能源管理系統的狀況，並設有警報功能，克服了現有系統的限制。該平台利用人工智能和建築資訊模型等前沿技術，實現數據驅動的能源管理，作用好比樓宇的「數碼化大腦」，能夠整合和分析來自不同裝置的數據，有助在能源監控和優化方面提供獨到的洞悉和機器學習模型。

Arup is the creative force at the heart of many prominent projects in the built environment. With 88 offices in 33 countries, Arup has more than 14,000 designers, engineers, planners, architects and consultants delivering innovative projects across the world.

Arup's Neuron Smart Building Digital Platform aims to overcome the constraints brought by existing building automation and energy management systems, which focus mainly on monitoring system health and providing alarm capabilities. The platform empowers data-driven energy management through AI and BIM, and serves as the 'digital brain' for buildings to consolidate and connect data from disparate devices to provide customised insight and machine-learning models for energy monitoring and optimization.

www.arup.com

香港總商會評審委員會之評語

奧雅納工程顧問展示了對追求建築管理極致科技的熱誠。Neuron 集 5G 技術、物聯網、大數據、雲端運算與人工智能技術於一身，是一款創新的控制台，協助物業管理團隊實時監控建築物和商場的系統運行表現，例如暖氣、通風和空調（HVAC 系統）運行狀況、管道滲漏和電源供應等。奧雅納利用 Neuron 開拓了全新的服務領域，以滿足不同建築物特定的建築績效管理需求。該系統有助加快樓宇數碼化，能夠配合香港發展智慧城市的步伐。Neuron 已經安裝於一幢樓高 48 層的全新甲級辦公大樓——太古坊一座，並已投入運作。

Comments by the HKGCC Judging Panel

Arup has demonstrated a strong passion for technological excellence in building management services. Neuron is an innovative console that embodies 5G, IoT, Big Data, Cloud Computing and AI technology to help monitor real-time performance of buildings and shopping malls through metrics such as heating, ventilation and air conditioning (HVAC systems), pipe health and power supply. The company has developed a new service niche to address building performance management needs across different building profiles. The system helps to expedite the digitalisation of buildings and is consistent with efforts by Hong Kong to become a Smart City. Neuron has been installed and is in operation at One Taikoo Place, a new triple Grade A 48-storey office tower.

必靈科技有限公司 BNET-TECH Company Limited

BNET

必靈科技是香港科技園「科技創業培育計劃」旗下的創新初創企業之一，其項目「優杖」在 2018 年獲得「社會創新及創業發展基金」資助。

「優杖」是一支多功能智能手杖，旨在減少使用者跌倒的風險。該智能手杖內置的警報系統連接流動程式，當偵測到手杖倒下且在 15 秒內未被撿起時，便會自動發出求救訊號，通知附近人士和照顧者。

「優杖」亦會因應溫度和燈光變化，全智能開關暖手及照明功能。

BNET-TECH is one of the innovative start-ups under the Incu-Tech programme at Hong Kong Science and Technology Park, and its STICKu project was funded by the Social Innovation and Entrepreneurship Development Fund in 2018.

STICKu is a multi-function smart walking cane that aims to reduce the fall risk of users. It includes an alarm system linked to a mobile application, which can automatically alert people nearby and carers of the user if the cane drops and is not picked up within 15 seconds.

STICKu also provides warming and lighting functions which will automatically turn on and off when there are changes in temperature and lighting conditions.

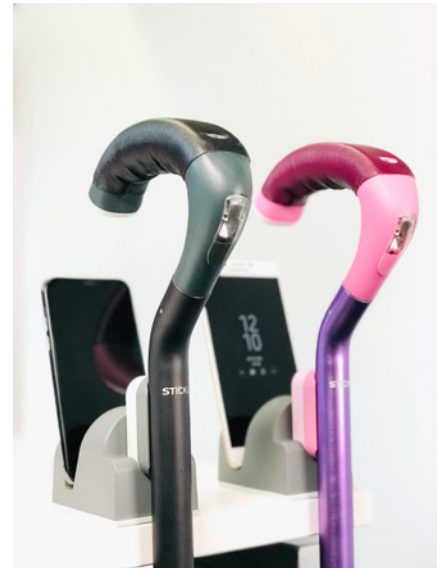

www.bnet-tech.com

電訊盈科企業方案有限公司 PCCW Solutions Limited

PCCW Solutions[®]

電訊盈科企業方案在香港、中國內地和東南亞提供資訊科技服務，以最新科技協助客戶實現業務目標和數碼轉型。

Infinitem™ Visum 為連接互聯網的智能鏡子，結合互動高清觸控式屏幕和預設的創新應用程式，為用戶提高生活便利、娛樂和生產力。該方案為不同行業預設專用應用程式，適用於物業發展商、酒店及零售店。

PCCW Solutions provides IT services in Hong Kong, Mainland China and Southeast Asia, using the latest technology to help its clients achieve their business goals and transform digitally.

Infinitem™ Visum is an Internet-connected smart mirror with an interactive, high-definition touchscreen, pre-loaded with innovative applications for personal convenience, entertainment and improved productivity. Customized versions with packages of industry-specific applications are available for property developers, hospitality providers and retailers.



www.pccwsolutions.com

相達生物科技國際有限公司 PHASE Scientific International Limited

PHASE SCIENTIFIC
相達生物科技

相達生物科技為一家發展蓬勃的生物科技初創企業，由美國加州大學的科學家所創立，致力協助人們掌握健康資訊。該公司自創的突破性樣本處理技術，令檢測工具變得更便捷、準確及實惠。

INDICAID® 妥析® 是市場上第一款快速檢測蛀牙風險的產品，用法簡單、操作便捷，適合個人和全家隨時隨地使用。

Founded by scientists from the University of California, PHASE Scientific is a fast-growing biotech start-up seeking to empower people by providing health information. Its sample preparation technology can make diagnostic tools faster, more accurate and more affordable.

The company's INDICAID® is the first personal-use product on the market to quickly assess the risk of tooth decay. It is an accurate, rapid and inexpensive test kit that helps users and their families track their risk of developing dental cavities, anytime and anywhere.



www.phasescientific.com

評審準則 Selection Criteria

產品/服務的 創新理念

- 原創性
- 構思過程
- 理念發展
- 實際表現

Product/Service Creativity

- Uniqueness
- Conceptualization
- Implementation
- Performance

企業對創意的重視

- 領導及文化

Emphasis on Corporate Innovation

- Leadership and Culture

商業表現

- 成就
- 前景

Commercial Performance

- Achievements
- Prospects

影響

- 工商界
- 香港

Impact

- on the Business
Community
- on Hong Kong

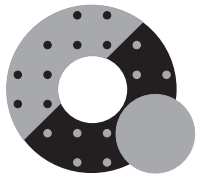

二零一九香港工商業獎：創意 2019 Hong Kong Awards for Industries: Innovation and Creativity

主辦機構
Organiser



Hong Kong General Chamber of Commerce
香港總商會1861

宗旨 Objectives

香港工商業獎：創意旨在促進工商界的創意文化和表揚優秀企業。優勝者需具備獨特的創新理念，重視和鼓勵創意，並能展示有關創建業務的業績、前景和影響。

The Hong Kong Awards for Industries: Innovation and Creativity aims to promote a culture of innovation and creativity amongst business sectors, and recognise the achievements of outstanding companies. The winning entries should be able to demonstrate the unique features of their creative concepts, their emphasis towards innovation, as well as the commercial viability and impact of their new businesses.

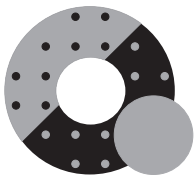

2019

香港工商業獎：創意

Hong Kong Awards for Industries:
Innovation and Creativity

二零一九香港工商業獎

顧客服務、創意、睿智生產力、科技成就、升級轉型組別
最終評審委員會

2019 Hong Kong Awards for Industries

Customer Service, Innovation and Creativity,
Smart Productivity, Technological Achievement and Upgrading and Transformation
Final Judging Panel



(由左起 From left)

于健安先生

Mr Emil Yu

香港總商會理事
General Committee Member
Hong Kong General Chamber of Commerce

余麗姚女士

Ms Ruth Yu

香港零售管理協會執行總監
Executive Director
Hong Kong Retail Management Association

郭位教授

Prof Way Kuo

最終評審委員會主席
Chairman of the Final Judging Panel
香港城市大學校長
President
City University of Hong Kong

徐建博士

Dr. Claudia Xu

香港科技園公司首席商務總監
Chief Commercial Officer
Hong Kong Science and Technology Parks Corporation

畢堅文先生

Mr Mohamed D. Butt

香港生產力促進局總裁
Executive Director
Hong Kong Productivity Council

冼雅恩先生

Mr Benedict Sin

香港青年工業家協會當然顧問
Ex-officio Advisor
Hong Kong Young Industrialists Council

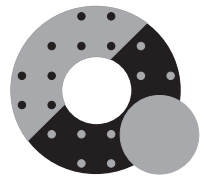

二零一九香港工商業獎：創意
香港總商會評審委員會
2019 Hong Kong Awards for Industries: Innovation and Creativity
HKGCC Judging Panel



(由左起 From left)

陳利華先生
Mr Watson Chan

香港總商會政策及商務發展副總裁
Deputy CEO, Policy & Business Development
Hong Kong General Chamber of Commerce (HKGCC)

廖家俊教授
Prof. Jack Lau

香港科技大學校董會會員及電子及計算機工程學系兼任教授
Council Member & Adjunct Professor
Department of Electronic and Computer Engineering
The Hong Kong University of Science and Technology

衛懿欣女士
Ms Christine Wai

香港特別行政區政府工業貿易署助理署長(工商業支援部)
Assistant Director-General (Industries Support)
Trade and Industry Department
HKSAR Government

于健安先生
Mr Emil Yu, JP

香港總商會評審委員會主席
Chairman, HKGCC Judging Panel
香港總商會理事
General Committee Member, HKGCC
啟東電纜有限公司總經理
General Manager, Keystone Electric Wire & Cable Co Ltd

李慧賢女士
Ms Angela Lee, BBS, JP

香港總商會中小型企業委員會副主席
Vice Chairman, Small & Medium Enterprises Committee, HKGCC
珍卡兒藥妝有限公司創辦人及主席
Founder and Chairman, Laboratory Janeclare Ltd

伍俊達先生
Mr Roy Ng

香港總商會中小型企業委員會主席
Chairman, Small & Medium Enterprises Committee, HKGCC
暉星(香港)有限公司主席及行政總裁
Chairman and CEO, Star Lite (HK) Ltd

黃玉娟女士
Ms Elsa Wong

香港總商會數碼、資訊及電訊委員會副主席
Vice Chairman, Digital, Information & Telecommunication
Committee, HKGCC
日本電氣香港有限公司董事總經理
Managing Director, NEC Hong Kong Ltd

黃洛鋒先生
Mr Adam Wong

安永會計師事務所審計服務高級經理
Senior Manager, Assurance, Ernst & Young
(獨立顧問·非評審委員會成員)
(Independent Consultant, not a judging panel member)

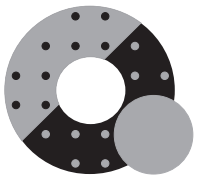

2019

香港工商業獎：創意

Hong Kong Awards for Industries:
Innovation and Creativity

二零一九香港工商業獎籌備委員會 2019 Organising Committee of the Hong Kong Awards for Industries

主席 CHAIRMAN

工業貿易署署長甄美薇女士
Ms Salina Yan
Director-General of Trade and Industry
Trade and Industry Department

成員 MEMBERS

香港零售管理協會執行總監余麗姚女士
Ms Ruth Yu
Executive Director
Hong Kong Retail Management Association

香港總商會政策及商務發展副總裁陳利華先生
Mr Watson Chan
Deputy CEO, Policy and Business Development
Hong Kong General Chamber of Commerce

香港生產力促進局總裁畢堅文先生
Mr Mohamed D. Butt
Executive Director
Hong Kong Productivity Council

香港科技園公司首席商務總監徐建博士
Dr Claudia Xu
Chief Commercial Officer
Hong Kong Science and Technology Parks Corporation

香港青年工業家協會當然顧問冼雅思先生
Mr Benedict Sin
Ex-officio Advisor
Hong Kong Young Industrialists Council

香港工業總會副主席嚴志明教授
Prof Eric C. Yim
Deputy Chairman
Federation of Hong Kong Industries

香港中華廠商聯合會聯絡及社會服務部總經理姜月燕女士
Ms Natalie Keung
General Manager, Liaison and Community Services
The Chinese Manufacturers' Association of Hong Kong

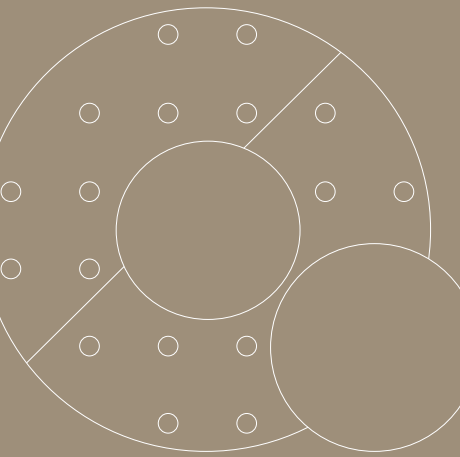

About Zhu Bi

In 1989, a striking symbol was designed for the Hong Kong Awards for Industry, expressed both in the award logo and in the trophies conferred on winners. The concept for the symbol is the juxtaposition of two precious elements, a pearl and a pierced jade amulet, to form a design which has happy connotations in both Chinese and western contexts. This symbol has been adopted by the Hong Kong Awards for Industries to recognise the excellence of Hong Kong enterprises.

The pearl (Zhu珠) is of particular significance to Hong Kong, an ancient source of finest pearls in China, and traditionally known as the Pearl of the Orient. The jade amulet (Bi 璧) represents the Heaven, according to Eastern Han scholar Zheng Xuan (鄭玄). The pierced disc resembles the ancient calligraphic symbol for the sun, and on the Hong Kong Awards for Industries logo the amulet is decorated with a stylised version of the traditional "grain" (穀) pattern. In Chinese, the two words together signify a perfect match. In the western context, the two symbols together form the letter "Q" which is widely associated with the concept of quality.

關於珠璧

在 1989 年，香港工業獎特別設計了一個匠心獨運的標誌，巧妙地將「珠」和「璧」這兩件寶物合併起來，成為一個中、英文中都有美好涵義的設計圖樣，用於獎項的標記和頒予得獎者的獎座。香港工商業獎沿用這個標誌，表彰本港企業的傑出成就。

「珠」對香港有特別深厚的意義，因為香港古時是中國出產最上好珍珠的地方，而且素有東方之珠的美譽。東漢經學家鄭玄認為「璧」象徵「天」。除此之外，璧的形狀有如中間有孔的圓碟，仿如古代書法中的「日」字；而香港工商業獎標誌中的璧，還以傳統的「穀」紋作裝飾。在中國語文上，「珠聯璧合」象徵「天衣無縫的配合」。以西方觀念來看，兩者併合成為英文字母「Q」，使人聯想起「品質」(Quality) 一詞。



Hong Kong General Chamber of Commerce
香港總商會 1861

About HKGCC

Founded in 1861, the Hong Kong General Chamber of Commerce is the oldest and most dynamic business organization in the city. Our members represent a wide spectrum of local, Mainland Chinese and international businesses. More than half of the flagship corporations listed on the Hang Seng Index are our members.

Combined, our membership, from renowned multinationals to thriving SMEs, employs around one-third of the local workforce. The Chamber serves as the "voice of business" in Hong Kong, and we help our members succeed through our core functions: advocacy, knowledge-based events, networking and a variety of business documentation services.

The Voice of Business

Breadth: We have representatives on more than 40 Government and non-Government advisory boards.

Depth: Chamber representatives also serve on the Executive Council, the Legislative Council of Hong Kong and the CPPCC Standing Committee.

Helping You Connect

Political network: Meet senior HKSAR, Mainland and overseas officials, Consuls General and Government advisers.

Business network: Mingle with the cream of Hong Kong's business community, and attend our regular networking events to expand your business and connections.

International network: More than 100 delegations from overseas and the Mainland visit the Chamber every year.

Knowledge network: Incoming delegations, overseas and Mainland missions, and knowledge-sharing sessions provide you with first-hand information, contacts and business opportunities.

Events

Broaden your business knowledge, connections and interests at the hundreds of events that we hold every year.

Pick the brains of our policy experts and industry leaders to stay on top of the latest market developments.

Choose from a variety of knowledge-based seminars, luncheons, workshops and training programmes to update your market information and skills.

Visit key Government and private facilities on our exclusive behind-the-scenes site visits.

Attend our networking cocktail receptions to expand your business circles, and also achieve a better work-life balance by participating in our cultural, sports, health and lifestyle events.

Download the Chamber's App, HKGCC Mobile, to get special deals, effortlessly register for Chamber events, and receive useful updates.

關於香港總商會

香港總商會始創於1861年，是本港歷史最悠久、與時並進的商業組織。我們的會員包羅香港、中國內地及國際企業，業務遍及各行各業。逾半的恒生指數上市旗艦公司，皆是總商會會員。

本會的會員企業涵蓋知名跨國公司和蓬勃發展的中小企，合共僱用約三分之一的本地勞動人口。總商會作為「商界之聲」，透過四大核心功能：政策倡議、資訊項目、聯誼交流，以及各種商貿簽證服務，協助會員成就輝煌事業。

商界之聲

廣泛代表：擔任超過40個政府及非政府諮詢委員會成員。

深入反映：會員當中有行政會議成員、立法會議員，以及全國政協常務委員。

商務聯繫

政界網絡：會見香港特區、內地及海外高官、總領事和政府顧問。

商界網絡：出席總商會定期舉辦的聯誼交流活動，與本港商界精英共聚，從而擴展業務和聯繫。

國際網絡：每年超過100個中外代表團到訪總商會。

資訊網絡：透過到訪代表團、外訪考察團和知識分享會，讓您掌握第一手資訊、人脈和商機。

商會活動

每年舉辦活動多達數百項，助您增進商業知識、擴闊人脈和拓展商機。

參考政策專家和業界領袖的專業意見，緊貼市場最新發展。

參加各式各樣的知識分享研討會、午餐會、工作坊和培訓課程，掌握市場最新資訊和技能。

獨家參觀政府和私人機構的設施，一睹幕後運作。

參加本會的聯誼酒會，擴大您的商業圈子，並通過我們的文化、體育、保健和休閒活動，促進工作與生活平衡。

下載總商會流動程式HKGCC Mobile，以獲取特別優惠、輕鬆報名參加總商會活動，以及收取最新的實用資訊。

HKGCC MOBILE





Hong Kong General Chamber of Commerce
香港總商會1861

香港金鐘道九十五號統一中心二十二樓
22/F United Centre, 95 Queensway, Hong Kong
電話 Tel: (852) 2529 9229 傳真 Fax: (852) 2527 9843
電郵 Email : chamber@chamber.org.hk
網址 Website : www.chamber.org.hk